

20D Series Tube Fittings

20,000 psig (1379 bar)



Part Number Crossover Charts	Technical Information	Tools and Installation Instructions	Subsea Valves	Sour Service Products	Valves	Line Filters	Quick Couplings	Tubing	Fittings
------------------------------	-----------------------	-------------------------------------	---------------	-----------------------	--------	--------------	-----------------	--------	----------

Contents

Nuts - N



A-05

Front Ferrules - FF



A-05

Rear Ferrules - RF



A-05

Plugs - DTP



A-05

Caps - DTC

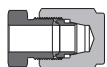

A-05

Unions - DU



A-06

Reducing Unions - DU



A-06

Bulkhead Unions - DBU



A-06

Male Connectors - DCM

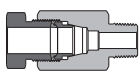

A-07

Female Connectors - DCF

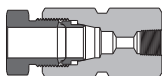

A-08

Union Elbows - DLU

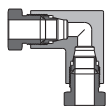

A-08

Union Reducing Elbows - DLU

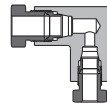

A-08

Male Elbows - DLM

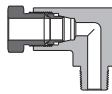

A-09

Union Tees - DT

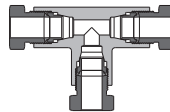

A-09

Male Branch Tees - DT

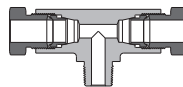

A-10

Union Crosses - DX

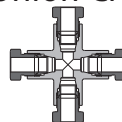

A-10

Reducers - DR



A-11

Port Connectors - DP



A-11

Adapters - DAM

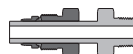

A-11

Installation Instructions

H-05

Connection Information

I-02

Ordering Number Description

A-12

Features

- Working pressure up to 20,000 psig (1379 bar)
- Easy and quick connection to T15 and T20D series tubing, tubing sizes available in 1/8", 1/4", 3/8", 1/2", 9/16", 3/4" and 1"
- High tensile 316 stainless steel material
- Nut threads coated with molybdenum disulfide-based lubricant to minimize the friction
- Long tube-support area to improve vibration resistance and line loads
- Every fitting marked with size, material and heat number
- EC-79 type approval for 70 MPa hydrogen system application

Standard Materials of Construction

Component	Material
<i>Body, ferrules</i>	316 stainless steel
Nut	316 stainless steel

Wetted components listed in italics.

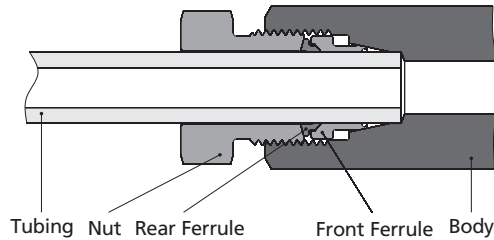

Working Pressure

- Working pressure is determined by the lowest working pressure of the ends.

Tube Ends

The working pressure of tube ends at ambient temperature is determined by the working pressure of the T15 and T20D Series tubing used. For details, please refer to "Working Pressure at Ambient Temperature" on B-06 and B-09.
CAUTION: 20D Series Tube Fittings are not applicable for use with T20M Series Tubing.

Male SAE O-ring Ends

Working pressure for male SAE O-ring end connections listed in this catalog is 10,000 psig (690 bar).

NPT Ends

NPT Size in.	Working Pressure psig (bar)
1/8	15,000 (1034)
1/4	
3/8	
1/2	
3/4	10,000 (690)
1	

T20D Series Tubing

Tube O.D. in.	Wall Thickness Tolerance in.	Working Pressure ^① psig (bar)
1/4	0.065	20,000 (1379)
3/8	0.083	
1/2	0.109	
9/16	0.125	
3/4	0.165	

① Working pressures are calculated from an S value of 50,000 psi (344 MPa) at -20 to 100°F (-28 to 38°C) for ASME B31.3 Chapter IX High Pressure Piping.

Working Temperature

Connection Type	Working Temperature Range, °F (°C)
Tube Ends	-325 to 800 (-198 to 427)
Male SAE O-ring Ends	0 to 400 (-17.8 to 204) ^①
NPT Ends	-325 to 400 (-198 to 204) ^{②③}

① The ends are supplied with a fluorocarbon FKM O-ring as standard, other materials of O-rings available.

② Always use proper thread sealants on tapered pipe threads.

③ The data are based on the working temperature range of the thread sealants. For the working temperature above 400°F (204°C), please contact FITOK Group or our authorized distributors.

Fittings
Tubing
Quick Couplings
Line Filters
Valves
Sour Service Products
Subsea Valves
Tools and Installation Instructions
Technical Information
Part Number Crossover Charts

Ordering Information and Dimensions

Dimensions are for reference only and are subject to change.

Nuts

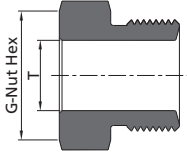

Tube		
T - Tube O.D. in.	Ordering Number	Dimensions, in. (mm)
		G
1/8	SS-N-DFF2	0.37 (9.5)
1/4	SS-N-DFF4	0.63 (15.9)
3/8	SS-N-DFF6	0.75 (19.1)
1/2	SS-N-DFF8	0.94 (23.8)
9/16	SS-N-DFF9	1.06 (27.0)
3/4	SS-N-DFF12	1.38 (34.9)
1	SS-N-DFF16	1.88 (47.6)

Front Ferrules

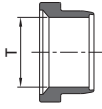

Tube	
T - Tube O.D. in.	Ordering Number
1/8	SS-FF-DFF2
1/4	SS-FF-DFF4
3/8	SS-FF-DFF6
1/2	SS-FF-DFF8
9/16	SS-FF-DFF9
3/4	SS-FF-DFF12
1	SS-FF-DFF16

Rear Ferrules



Tube	
T - Tube O.D. in.	Ordering Number
1/8	SS-RF-DFF2
1/4	SS-RF-DFF4
3/8	SS-RF-DFF6
1/2	SS-RF-DFF8
9/16	SS-RF-DFF9
3/4	SS-RF-DFF12
1	SS-RF-DFF16

Plugs^①

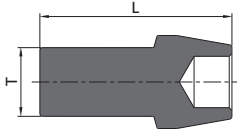

Tube		
T - Tube O.D. in.	Ordering Number	Dimensions, in. (mm)
		L
1/8	SS-DTP-DFF2	0.95 (24.2)
1/4	SS-DTP-DFF4	1.20 (30.4)
3/8	SS-DTP-DFF6	1.19 (30.2)
1/2	SS-DTP-DFF8	1.36 (34.6)
9/16	SS-DTP-DFF9	1.73 (44.0)
3/4	SS-DTP-DFF12	2.30 (58.3)
1	SS-DTP-DFF16	2.64 (67.0)

^① When using plug, ferrules are not required.

Caps

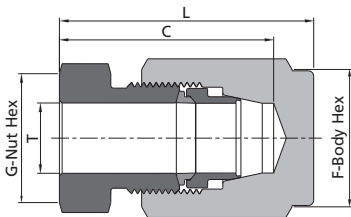

Tube					
T - Tube O.D. in.	Ordering Number	Dimensions, in. (mm)			
		L	C	F	G
1/8	SS-DTC-DFF2	1.22 (31.1)	1.07 (27.2)	0.50 (12.7)	0.37 (9.5)
1/4	SS-DTC-DFF4	1.70 (43.1)	1.38 (35.2)	0.63 (15.9)	0.63 (15.9)
3/8	SS-DTC-DFF6	1.76 (44.8)	1.42 (36.1)	0.75 (19.1)	0.75 (19.1)
1/2	SS-DTC-DFF8	1.85 (47.0)	1.56 (39.6)	1.00 (25.4)	0.94 (23.8)
9/16	SS-DTC-DFF9	2.46 (62.6)	1.93 (49.0)	1.13 (28.6)	1.06 (27.0)
3/4	SS-DTC-DFF12	3.22 (81.9)	2.49 (63.3)	1.50 (38.1)	1.38 (34.9)
1	SS-DTC-DFF16	4.06 (103.2)	3.24 (82.3)	2.00 (50.8)	1.88 (47.6)

Unions

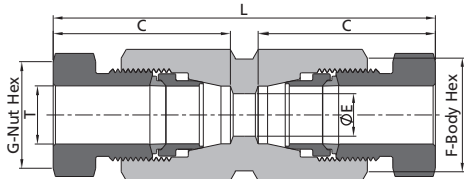

Tube		Dimensions, in. (mm)				
T - Tube O.D. in.	Ordering Number	L	C	E	F	G
1/8	SS-DU-DFF2	2.45 (62.2)	1.07 (27.2)	0.09 (2.4)	0.50 (12.7)	0.37 (9.5)
1/4	SS-DU-DFF4	3.00 (76.2)	1.38 (35.2)	0.19 (4.8)	0.63 (15.9)	0.63 (15.9)
3/8	SS-DU-DFF6	3.07 (77.9)	1.42 (36.1)	0.25 (6.4)	0.75 (19.1)	0.75 (19.1)
1/2	SS-DU-DFF8	3.36 (85.4)	1.56 (39.6)	0.37 (9.5)	1.00 (25.4)	0.94 (23.8)
9/16	SS-DU-DFF9	4.11 (104.4)	1.93 (49.0)	0.41 (10.4)	1.13 (28.6)	1.06 (27.0)
3/4	SS-DU-DFF12	5.38 (136.7)	2.49 (63.3)	0.56 (14.2)	1.50 (38.1)	1.38 (34.9)
1	SS-DU-DFF16	7.06 (179.3)	3.24 (82.3)	0.69 (17.5)	2.00 (50.8)	1.88 (47.6)

Reducing Unions

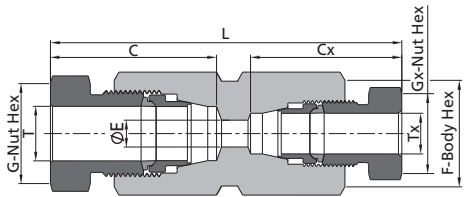

Tube			Dimensions, in. (mm)						
T - Tube O.D. in.	Tx - Tube O.D. in.	Ordering Number	L	C	Cx	E	F	G	Gx
1/4	1/8	SS-DU-DFF4-DFF2	2.73 (69.4)	1.39 (35.2)	1.07 (27.2)	0.09 (2.4)	0.63 (15.9)	0.63 (15.9)	0.37 (9.5)
3/8	1/8	SS-DU-DFF6-DFF2	2.77 (70.3)	1.42 (36.1)	1.07 (27.2)	0.09 (2.4)	0.75 (19.1)	0.75 (19.1)	0.37 (9.5)
3/8	1/4	SS-DU-DFF6-DFF4	3.06 (77.6)	1.42 (36.1)	1.39 (35.2)	0.19 (4.8)	0.75 (19.1)	0.75 (19.1)	0.63 (15.9)
1/2	1/4	SS-DU-DFF8-DFF4	3.35 (85.1)	1.56 (39.6)	1.39 (35.2)	0.19 (4.8)	1.00 (25.4)	0.94 (23.8)	0.63 (15.9)
1/2	3/8	SS-DU-DFF8-DFF6	3.32 (84.3)	1.56 (39.6)	1.42 (36.1)	0.25 (6.4)	1.00 (25.4)	0.94 (23.8)	0.75 (19.1)
9/16	1/2	SS-DU-DFF9-DFF8	4.04 (102.5)	1.93 (49.0)	1.56 (39.6)	0.37 (9.5)	1.13 (28.6)	1.06 (27.0)	0.94 (23.8)
3/4	1/2	SS-DU-DFF12-DFF8	4.73 (120.2)	2.49 (63.3)	1.56 (39.6)	0.37 (9.5)	1.50 (38.1)	1.38 (34.9)	0.94 (23.8)
1	1/2	SS-DU-DFF16-DFF8	5.35 (135.9)	3.24 (82.3)	1.56 (39.6)	0.37 (9.5)	2.00 (50.8)	1.88 (47.6)	0.94 (23.8)

Bulkhead Unions

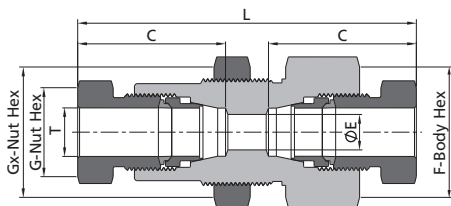

Tube		Dimensions, in. (mm)							
T - Tube O.D. in.	Ordering Number	L	C	E	F	G	Gx	Panel Hole Size	Maximum Panel Thickness
1/8	SS-DBU-DFF2	2.95 (75.0)	1.07 (27.2)	0.09 (2.4)	0.75 (19.1)	0.37 (9.5)	0.81 (20.6)	0.69 (17.5)	0.38 (9.7)
1/4	SS-DBU-DFF4	3.27 (83.1)	1.38 (35.2)	0.19 (4.8)	1.00 (25.4)	0.63 (15.9)	1.06 (27.0)	0.94 (23.9)	0.38 (9.7)
3/8	SS-DBU-DFF6	3.21 (81.6)	1.42 (36.1)	0.25 (6.4)	1.00 (25.4)	0.75 (19.1)	1.06 (27.0)	0.94 (23.9)	0.38 (9.7)
1/2	SS-DBU-DFF8	3.93 (99.8)	1.56 (39.6)	0.37 (9.5)	1.38 (34.9)	0.94 (23.8)	1.38 (34.9)	1.13 (28.6)	0.38 (9.7)
9/16	SS-DBU-DFF9	4.64 (117.8)	1.93 (49.0)	0.41 (10.4)	1.63 (41.3)	1.06 (27.0)	1.63 (41.3)	1.33 (33.7)	0.38 (9.7)
3/4	SS-DBU-DFF12	5.82 (147.9)	2.49 (63.3)	0.56 (14.2)	1.87 (47.6)	1.38 (34.9)	1.87 (47.6)	1.64 (41.7)	0.38 (9.7)
1	SS-DBU-DFF16	7.45 (189.3)	3.24 (82.3)	0.69 (17.5)	2.50 (63.5)	1.88 (47.6)	2.50 (63.5)	2.27 (57.6)	0.38 (9.7)

Unions	Fittings
Reducing Unions	Tubing
	Quick Couplings
	Line Filters
	Valves
	Sour Service Products
	Subsea Valves
	Tools and Installation Instructions
	Technical Information
	Part Number Crossover Charts

Male Connectors

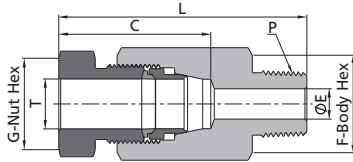

Tube			NPT Thread				
T - Tube O.D. in.	P - NPT Size in.	Ordering Number	Dimensions, in. (mm)				
			L	C	E	F	G
1/8	1/8	SS-DCM-DFF2-NS2	1.60 (40.6)	1.07 (27.2)	0.09 (2.4)	0.50 (12.7)	0.37 (9.5)
1/8	1/4	SS-DCM-DFF2-NS4	1.72 (43.8)	1.07 (27.2)	0.09 (2.4)	0.56 (14.3)	0.37 (9.5)
1/8	3/8	SS-DCM-DFF2-NS6	1.72 (43.8)	1.07 (27.2)	0.09 (2.4)	0.69 (17.5)	0.37 (9.5)
1/4	1/8	SS-DCM-DFF4-NS2	1.95 (49.5)	1.39 (35.2)	0.19 (4.8)	0.63 (15.9)	0.63 (15.9)
1/4	1/4	SS-DCM-DFF4-NS4	2.08 (52.8)	1.39 (35.2)	0.19 (4.8)	0.63 (15.9)	0.63 (15.9)
1/4	3/8	SS-DCM-DFF4-NS6	2.08 (52.8)	1.39 (35.2)	0.19 (4.8)	0.69 (17.5)	0.63 (15.9)
1/4	1/2	SS-DCM-DFF4-NS8	2.32 (59.0)	1.39 (35.2)	0.19 (4.8)	0.87 (22.2)	0.63 (15.9)
3/8	1/4	SS-DCM-DFF6-NS4	2.17 (55.1)	1.42 (36.1)	0.25 (6.4)	0.75 (19.1)	0.75 (19.1)
3/8	3/8	SS-DCM-DFF6-NS6	2.17 (55.1)	1.42 (36.1)	0.25 (6.4)	0.75 (19.1)	0.75 (19.1)
3/8	1/2	SS-DCM-DFF6-NS8	2.30 (58.3)	1.42 (36.1)	0.25 (6.4)	0.87 (22.2)	0.75 (19.1)
1/2	1/4	SS-DCM-DFF8-NS4	2.53 (64.3)	1.56 (39.6)	0.25 (6.4)	1.00 (25.4)	0.94 (23.8)
1/2	3/8	SS-DCM-DFF8-NS6	2.53 (64.3)	1.56 (39.6)	0.31 (7.9)	1.00 (25.4)	0.94 (23.8)
1/2	1/2	SS-DCM-DFF8-NS8	2.65 (67.4)	1.56 (39.6)	0.37 (9.5)	1.00 (25.4)	0.94 (23.8)
1/2	3/4	SS-DCM-DFF8-NS12	2.53 (64.3)	1.56 (39.6)	0.37 (9.5)	1.06 (27.0)	0.94 (23.8)
9/16	1/4	SS-DCM-DFF9-NS4	3.03 (77.0)	1.93 (49.0)	0.25 (6.4)	1.13 (28.6)	1.06 (27.0)
9/16	1/2	SS-DCM-DFF9-NS8	3.11 (79.1)	1.93 (49.0)	0.38 (9.6)	1.13 (28.6)	1.06 (27.0)
3/4	1/2	SS-DCM-DFF12-NS8	3.74 (95.1)	2.49 (63.3)	0.38 (9.6)	1.50 (38.1)	1.38 (34.9)
3/4	3/4	SS-DCM-DFF12-NS12	3.74 (95.1)	2.49 (63.3)	0.56 (14.2)	1.50 (38.1)	1.38 (34.9)
3/4	1	SS-DCM-DFF12-NS16	3.83 (97.4)	2.49 (63.3)	0.56 (14.2)	1.50 (38.1)	1.38 (34.9)
1	1/2	SS-DCM-DFF16-NS8	4.46 (113.2)	3.24 (82.3)	0.38 (9.6)	2.00 (50.8)	1.88 (47.6)
1	3/4	SS-DCM-DFF16-NS12	4.46 (113.2)	3.24 (82.3)	0.58 (14.8)	2.00 (50.8)	1.88 (47.6)
1	1	SS-DCM-DFF16-NS16	4.65 (118.1)	3.24 (82.3)	0.69 (17.5)	2.00 (50.8)	1.88 (47.6)

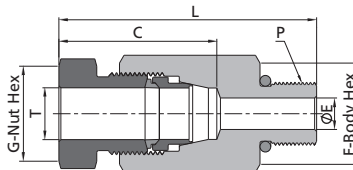

Tube			Male SAE O-ring				
T - Tube O.D. in.	P - SAE/MS Thread Size	Ordering Number	Dimensions, in. (mm)				
			L	C	E	F	G
1/8	7/16-20	SS-DCM-DFF2-SH7	1.60 (40.6)	1.07 (27.2)	0.09 (2.4)	0.56 (14.3)	0.37 (9.5)
1/8	9/16-18	SS-DCM-DFF2-SH9	1.66 (42.2)	1.07 (27.2)	0.09 (2.4)	0.69 (17.5)	0.37 (9.5)
1/4	7/16-20	SS-DCM-DFF4-SH7	2.04 (51.7)	1.39 (35.2)	0.18 (4.5)	0.63 (15.9)	0.63 (15.9)
1/4	9/16-18	SS-DCM-DFF4-SH9	2.07 (52.7)	1.39 (35.2)	0.19 (4.8)	0.69 (17.5)	0.63 (15.9)
3/8	7/16-20	SS-DCM-DFF6-SH7	2.09 (53.0)	1.42 (36.1)	0.18 (4.5)	0.75 (19.1)	0.75 (19.1)
3/8	9/16-18	SS-DCM-DFF6-SH9	2.13 (54.0)	1.42 (36.1)	0.25 (6.4)	0.75 (19.1)	0.75 (19.1)
1/2	7/16-20	SS-DCM-DFF8-SH7	2.49 (63.3)	1.56 (39.6)	0.18 (4.5)	1.00 (25.4)	0.94 (23.8)
1/2	9/16-18	SS-DCM-DFF8-SH9	2.49 (63.3)	1.56 (39.6)	0.30 (7.5)	1.00 (25.4)	0.94 (23.8)

Female Connectors

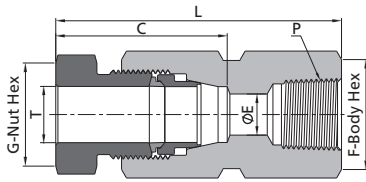

Tube			NPT Thread				
T - Tube O.D. in.	P - NPT Size in.	Ordering Number	Dimensions, in. (mm)				
			L	C	E	F	G
1/8	1/8	SS-DCF-DFF2-FNS2	1.97 (50.1)	1.07 (27.2)	0.09 (2.4)	0.63 (15.9)	0.37 (9.5)
1/8	1/4	SS-DCF-DFF2-FNS4	2.01 (53.3)	1.07 (27.2)	0.09 (2.4)	0.94 (23.8)	0.37 (9.5)
1/4	1/4	SS-DCF-DFF4-FNS4	2.33 (59.1)	1.38 (35.2)	0.19 (4.8)	0.94 (23.8)	0.63 (15.9)
3/8	1/4	SS-DCF-DFF6-FNS4	2.29 (58.1)	1.42 (36.1)	0.25 (6.4)	0.94 (23.8)	0.75 (19.1)
1/2	1/4	SS-DCF-DFF8-FNS4	2.78 (70.6)	1.56 (39.6)	0.37 (9.5)	1.00 (25.4)	0.94 (23.8)
1/2	1/2	SS-DCF-DFF8-FNS8	3.03 (77.0)	1.56 (39.6)	0.37 (9.5)	1.38 (34.9)	0.94 (23.8)
3/4	1/2	SS-DCF-DFF12-FNS8	3.85 (97.8)	2.49 (63.3)	0.56 (14.2)	1.50 (38.1)	1.38 (34.9)
1	1	SS-DCF-DFF16-FNS16	4.75 (120.7)	3.24 (82.3)	0.69 (17.5)	2.00 (50.8)	1.88 (47.6)

Union Elbows

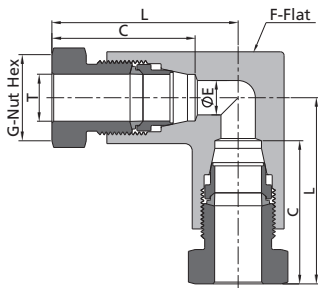

Tube		Dimensions, in. (mm)				
T - Tube O.D. in.	Ordering Number	L	C	E	F	G
1/8	SS-DLU-DFF2	1.29 (32.7)	1.07 (27.2)	0.09 (2.4)	0.63 (15.9)	0.37 (9.5)
1/4	SS-DLU-DFF4	1.70 (43.1)	1.38 (35.2)	0.19 (4.8)	0.63 (15.9)	0.63 (15.9)
3/8	SS-DLU-DFF6	1.67 (42.4)	1.42 (36.1)	0.25 (6.4)	0.75 (19.1)	0.75 (19.1)
1/2	SS-DLU-DFF8	2.03 (51.6)	1.56 (39.6)	0.37 (9.5)	1.00 (25.4)	0.94 (23.8)
9/16	SS-DLU-DFF9	2.43 (61.8)	1.93 (49.0)	0.41 (10.4)	1.38 (34.9)	1.06 (27.0)
3/4	SS-DLU-DFF12	3.11 (79.1)	2.49 (63.3)	0.56 (14.2)	1.50 (38.1)	1.38 (34.9)
1	SS-DLU-DFF16	4.14 (105.2)	3.24 (82.3)	0.69 (17.5)	2.00 (50.8)	1.88 (47.6)

Union Reducing Elbows

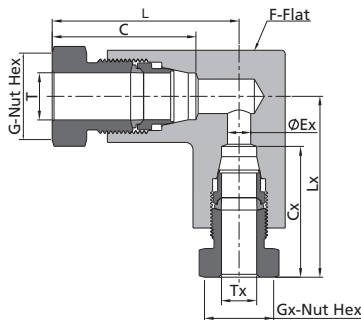

Tube			Dimensions, in. (mm)								
T - Tube O.D. in.	Tx - Tube O.D. in.	Ordering Number	L	Lx	C	Cx	Ex	F	G	Gx	
1/4	1/8	SS-DLU-DFF4-DFF2	1.70 (43.1)	1.37 (34.7)	1.38 (35.2)	1.07 (27.2)	0.09 (2.4)	0.63 (15.9)	0.63 (15.9)	0.37 (9.5)	
3/8	1/8	SS-DLU-DFF6-DFF2	1.67 (42.4)	1.33 (33.7)	1.42 (36.1)	1.07 (27.2)	0.09 (2.4)	0.75 (19.1)	0.75 (19.1)	0.37 (9.5)	
3/8	1/4	SS-DLU-DFF6-DFF4	1.67 (42.4)	1.70 (43.1)	1.42 (36.1)	1.38 (35.2)	0.19 (4.8)	0.75 (19.1)	0.75 (19.1)	0.63 (15.9)	
1/2	1/4	SS-DLU-DFF8-DFF4	2.03 (51.6)	1.95 (49.5)	1.56 (39.6)	1.38 (35.2)	0.19 (4.8)	0.94 (23.8)	1.00 (25.4)	0.63 (15.9)	
1/2	3/8	SS-DLU-DFF8-DFF6	2.03 (51.6)	1.96 (49.8)	1.56 (39.6)	1.42 (36.1)	0.25 (6.4)	0.94 (23.8)	1.00 (25.4)	0.75 (19.1)	
9/16	1/2	SS-DLU-DFF9-DFF8	2.43 (61.8)	2.37 (60.2)	1.93 (49.0)	1.56 (39.6)	0.37 (9.5)	1.38 (34.9)	1.06 (27.0)	0.94 (23.8)	
3/4	1/2	SS-DLU-DFF12-DFF8	3.11 (79.1)	2.49 (63.3)	2.49 (63.3)	1.56 (39.6)	0.37 (9.5)	1.50 (38.1)	1.38 (34.9)	0.94 (23.8)	
1	1/2	SS-DLU-DFF16-DFF8	4.14 (105.2)	2.47 (62.8)	3.24 (82.3)	1.56 (39.6)	0.37 (9.5)	2.00 (50.8)	1.88 (47.6)	0.94 (23.8)	
1	9/16	SS-DLU-DFF16-DFF9	4.14 (105.2)	2.82 (71.6)	3.24 (82.3)	1.93 (49.0)	0.41 (10.4)	2.00 (50.8)	1.88 (47.6)	1.06 (27.0)	
1	3/4	SS-DLU-DFF16-DFF12	4.14 (105.2)	3.45 (87.6)	3.24 (82.3)	2.49 (63.3)	0.56 (14.2)	2.00 (50.8)	1.88 (47.6)	1.38 (34.9)	

Fittings
Tubing
Quick Couplings
Line Filters
Valves
Sour Service Products
Subsea Valves
Tools and Installation Instructions
Technical Information
Part Number Crossover Charts

Male Elbows

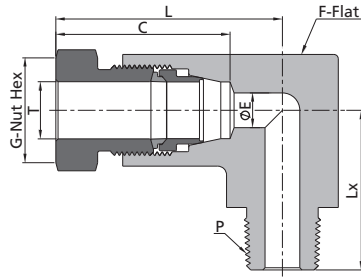

Tube			NPT Thread						
T - Tube O.D. in.	P - NPT Size in.	Ordering Number	Dimensions, in. (mm)						
			L	Lx	C	E	F	G	
1/8	1/8	SS-DLM-DFF2-NS2	1.29 (32.7)	0.79 (20.0)	1.07 (27.2)	0.09 (2.4)	0.63 (15.9)	0.37 (9.5)	
1/8	1/4	SS-DLM-DFF2-NS4	1.39 (35.3)	1.00 (25.4)	1.07 (27.2)	0.09 (2.4)	0.63 (15.9)	0.37 (9.5)	
1/8	3/8	SS-DLM-DFF2-NS6	1.47 (37.4)	1.00 (25.4)	1.07 (27.2)	0.09 (2.4)	0.75 (19.1)	0.37 (9.5)	
1/4	1/4	SS-DLM-DFF4-NS4	1.70 (43.1)	0.94 (23.8)	1.38 (35.2)	0.19 (4.8)	0.63 (15.9)	0.63 (15.9)	
1/4	3/8	SS-DLM-DFF4-NS6	1.70 (43.1)	1.00 (25.4)	1.38 (35.2)	0.19 (4.8)	0.75 (19.1)	0.63 (15.9)	
1/4	1/2	SS-DLM-DFF4-NS8	1.70 (43.1)	1.38 (34.9)	1.38 (35.2)	0.19 (4.8)	1.00 (25.4)	0.63 (15.9)	
3/8	1/4	SS-DLM-DFF6-NS4	1.67 (42.4)	1.00 (25.4)	1.42 (36.1)	0.25 (6.4)	0.75 (19.1)	0.75 (19.1)	
3/8	3/8	SS-DLM-DFF6-NS6	1.67 (42.4)	1.06 (27.0)	1.42 (36.1)	0.25 (6.4)	0.75 (19.1)	0.75 (19.1)	
3/8	1/2	SS-DLM-DFF6-NS8	1.67 (42.4)	1.38 (34.9)	1.42 (36.1)	0.25 (6.4)	1.00 (25.4)	0.75 (19.1)	
1/2	1/4	SS-DLM-DFF8-NS4	2.03 (51.6)	1.19 (30.2)	1.56 (39.6)	0.25 (6.4)	1.00 (25.4)	0.94 (23.8)	
1/2	3/8	SS-DLM-DFF8-NS6	2.03 (51.6)	1.19 (30.2)	1.56 (39.6)	0.31 (7.9)	1.00 (25.4)	0.94 (23.8)	
1/2	1/2	SS-DLM-DFF8-NS8	2.03 (51.6)	1.38 (34.9)	1.56 (39.6)	0.37 (9.5)	1.00 (25.4)	0.94 (23.8)	
9/16	1/2	SS-DLM-DFF9-NS8	2.43 (61.8)	1.56 (39.5)	1.93 (49.0)	0.38 (9.6)	1.38 (34.9)	1.06 (27.0)	
3/4	1/2	SS-DLM-DFF12-NS8	3.11 (79.1)	1.73 (44.0)	2.49 (63.3)	0.38 (9.6)	1.50 (38.1)	1.38 (34.9)	
3/4	3/4	SS-DLM-DFF12-NS12	3.11 (79.1)	1.73 (44.0)	2.49 (63.3)	0.56 (14.2)	1.50 (38.1)	1.38 (34.9)	
1	1/2	SS-DLM-DFF16-NS8	4.14 (105.2)	2.06 (52.4)	3.24 (82.3)	0.38 (9.6)	2.00 (50.8)	1.88 (47.6)	
1	3/4	SS-DLM-DFF16-NS12	4.14 (105.2)	2.06 (52.4)	3.24 (82.3)	0.58 (14.8)	2.00 (50.8)	1.88 (47.6)	
1	1	SS-DLM-DFF16-NS16	4.14 (105.2)	2.25 (57.2)	3.24 (82.3)	0.69 (17.5)	2.00 (50.8)	1.88 (47.6)	

Union Tees

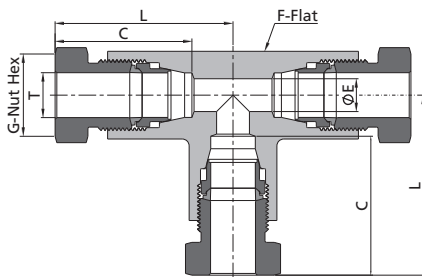

Tube		Dimensions, in. (mm)				
T - Tube O.D. in.	Ordering Number	L	C	E	F	G
1/8	SS-DT-DFF2	1.37 (34.7)	1.07 (27.2)	0.09 (2.4)	0.63 (15.9)	0.37 (9.5)
1/4	SS-DT-DFF4	1.70 (43.1)	1.38 (35.2)	0.19 (4.8)	0.63 (15.9)	0.63 (15.9)
3/8	SS-DT-DFF6	1.67 (42.4)	1.42 (36.1)	0.25 (6.4)	0.75 (19.1)	0.75 (19.1)
1/2	SS-DT-DFF8	2.03 (51.6)	1.56 (39.6)	0.37 (9.5)	1.00 (25.4)	0.94 (23.8)
9/16	SS-DT-DFF9	2.43 (61.8)	1.93 (49.0)	0.41 (10.4)	1.38 (34.9)	1.06 (27.0)
3/4	SS-DT-DFF12	3.11 (79.1)	2.49 (63.3)	0.56 (14.2)	1.50 (38.1)	1.38 (34.9)
1	SS-DT-DFF16	4.14 (105.2)	3.24 (82.3)	0.69 (17.5)	2.00 (50.8)	1.88 (47.6)

Male Branch Tees

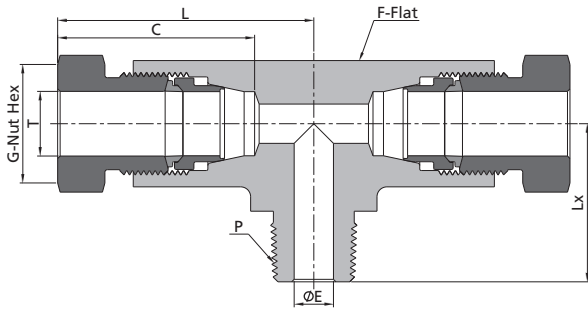

Tube			NPT Thread						
T - Tube O.D. in.	P - NPT Size in.	Ordering Number	Dimensions, in. (mm)						
			L	Lx	C	E	F	G	
1/8	1/8	SS-DT-DFF2-DFF2-NS2	1.37 (34.7)	0.79 (20.0)	1.07 (27.2)	0.09 (2.4)	0.63 (15.9)	0.37 (9.5)	
1/8	1/4	SS-DT-DFF2-DFF2-NS4	1.37 (34.7)	1.00 (25.4)	1.07 (27.2)	0.09 (2.4)	0.63 (15.9)	0.37 (9.5)	
1/4	1/8	SS-DT-DFF4-DFF4-NS2	1.70 (43.1)	0.81 (20.6)	1.38 (35.2)	0.19 (4.8)	0.63 (15.9)	0.63 (15.9)	
1/4	1/4	SS-DT-DFF4-DFF4-NS4	1.70 (43.1)	1.00 (25.4)	1.38 (35.2)	0.19 (4.8)	0.63 (15.9)	0.63 (15.9)	
3/8	1/4	SS-DT-DFF6-DFF6-NS4	1.67 (42.4)	1.06 (27.0)	1.42 (36.1)	0.25 (6.4)	0.75 (19.1)	0.75 (19.1)	
1/2	1/4	SS-DT-DFF8-DFF8-NS4	2.03 (51.6)	1.19 (30.2)	1.56 (39.6)	0.25 (6.4)	1.00 (25.4)	0.94 (23.8)	
1/2	3/8	SS-DT-DFF8-DFF8-NS6	2.03 (51.6)	1.19 (30.2)	1.56 (39.6)	0.31 (7.9)	1.00 (25.4)	0.94 (23.8)	
3/4	3/4	SS-DT-DFF12-DFF12-NS12	3.11 (79.1)	1.73 (44.0)	2.49 (63.3)	0.56 (14.2)	1.50 (38.1)	1.38 (34.9)	
1	1/2	SS-DT-DFF16-DFF16-NS8	4.14 (105.2)	2.06 (52.4)	3.24 (82.3)	0.38 (9.6)	2.00 (50.8)	1.88 (47.6)	
1	3/4	SS-DT-DFF16-DFF16-NS12	4.14 (105.2)	2.06 (52.4)	3.24 (82.3)	0.58 (14.8)	2.00 (50.8)	1.88 (47.6)	
1	1	SS-DT-DFF16-DFF16-NS16	4.14 (105.2)	2.25 (57.2)	3.24 (82.3)	0.69 (17.5)	2.00 (50.8)	1.88 (47.6)	

Union Crosses

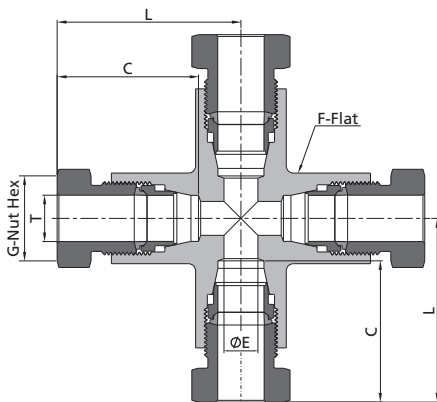

Tube		Dimensions, in. (mm)				
T - Tube O.D. in.	Ordering Number	L	C	E	F	G
1/8	SS-DX-DFF2	1.37 (34.7)	1.07 (27.2)	0.09 (2.4)	0.63 (15.9)	0.37 (9.5)
1/4	SS-DX-DFF4	1.70 (43.1)	1.38 (35.2)	0.19 (4.8)	0.63 (15.9)	0.63 (15.9)
3/8	SS-DX-DFF6	1.67 (42.4)	1.42 (36.1)	0.25 (6.4)	0.75 (19.1)	0.75 (19.1)
1/2	SS-DX-DFF8	2.03 (51.6)	1.56 (39.6)	0.37 (9.5)	1.00 (25.4)	0.94 (23.8)
9/16	SS-DX-DFF9	2.43 (61.8)	1.93 (49.0)	0.41 (10.4)	1.38 (34.9)	1.06 (27.0)
3/4	SS-DX-DFF12	3.01 (76.4)	2.49 (63.3)	0.56 (14.2)	1.50 (38.1)	1.38 (34.9)
1	SS-DX-DFF16	4.14 (105.2)	3.24 (82.3)	0.69 (17.5)	2.00 (50.8)	1.88 (47.6)

Fittings
Tubing
Quick Couplings
Line Filters
Valves
Sour Service Products
Subsea Valves
Tools and Installation Instructions
Technical Information
Part Number Crossover Charts

Reducers^①

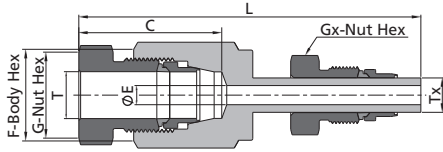

Tube									
T - Tube O.D. in.	Tx - Tube O.D. in.	Ordering Number	Dimensions, in. (mm)						
			L	C	E	F	G	Gx	
1/4	3/8	SS-DR-DFF4-DFT6	3.20 (82.1)	1.38 (35.2)	0.19 (4.8)	0.63 (15.9)	0.63 (15.9)	0.75 (19.1)	
1/4	1/2	SS-DR-DFF4-DFT8	3.37 (85.5)	1.38 (35.2)	0.19 (4.8)	0.63 (15.9)	0.63 (15.9)	0.94 (23.8)	
3/8	1/2	SS-DR-DFF6-DFT8	3.43 (87.1)	1.42 (36.1)	0.25 (6.4)	0.75 (19.1)	0.75 (19.1)	0.94 (23.8)	
1/2	3/8	SS-DR-DFF8-DFT6	3.53 (89.7)	1.56 (39.6)	0.21 (5.3)	1.00 (25.4)	0.94 (23.8)	0.75 (19.1)	
1/2	3/4	SS-DR-DFF8-DFT12	5.13 (130.4)	1.56 (39.6)	0.37 (9.5)	1.00 (25.4)	0.94 (23.8)	1.38 (34.9)	
9/16	3/4	SS-DR-DFF9-DFT12	5.32 (135.1)	1.93 (49.0)	0.41 (10.4)	1.13 (28.6)	1.06 (27.0)	1.38 (34.9)	
3/4	9/16	SS-DR-DFF12-DFT9	5.46 (138.6)	2.49 (63.3)	0.31 (7.9)	1.50 (38.1)	1.38 (34.9)	1.06 (27.0)	
1	3/4	SS-DR-DFF16-DFT12	5.06 (128.5)	3.24 (82.3)	0.42 (10.7)	2.00 (50.8)	1.88 (47.6)	1.38 (34.9)	

① The right ends of reducers will be preassembled with ferrules before shipping. Please follow the Reinstallation Instructions in H-06 when installing the reducers.

Port Connectors^①

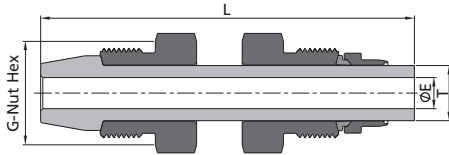

Tube				
T - Tube O.D. in.	Ordering Number	Dimensions, in. (mm)		
		L	E	G
1/8	SS-DP-DFF2	2.06 (52.2)	0.06 (1.6)	0.37 (9.5)
1/4	SS-DP-DFF4	2.66 (67.5)	0.12 (3.0)	0.63 (15.9)
3/8	SS-DP-DFF6	2.72 (69.0)	0.21 (5.3)	0.75 (19.1)
1/2	SS-DP-DFF8	3.04 (77.3)	0.28 (7.1)	0.94 (23.8)
9/16	SS-DP-DFF9	3.80 (96.5)	0.31 (7.9)	1.06 (27.0)
3/4	SS-DP-DFF12	4.83 (122.8)	0.42 (10.7)	1.38 (34.9)
1	SS-DP-DFF16	5.98 (152.0)	0.66 (16.7)	1.88 (47.6)

① The port connectors will be preassembled with ferrules before shipping. Please follow the Reinstallation Instructions in H-06 when installing the port connectors.

Adapters^①

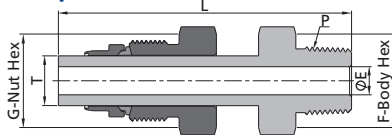

Tube				NPT Thread			
T - Tube O.D. in.	P - NPT Size	Ordering Number	Dimensions, in. (mm)				
			L	E	F	G	
1/4	1/4	SS-DAM-DFT4-NS4	2.30 (58.5)	0.12 (3.0)	0.56 (14.3)	0.63 (15.9)	
3/8	1/4	SS-DAM-DFT6-NS4	2.38 (60.4)	0.21 (5.3)	0.56 (14.3)	0.75 (19.1)	
3/8	1/2	SS-DAM-DFT6-NS8	2.67 (67.9)	0.21 (5.3)	0.87 (22.2)	0.75 (19.1)	
1/2	1/4	SS-DAM-DFT8-NS4	2.55 (64.8)	0.25 (6.4)	0.56 (14.3)	0.94 (23.8)	
1/2	1/2	SS-DAM-DFT8-NS8	2.84 (72.2)	0.28 (7.1)	0.87 (22.2)	0.94 (23.8)	
9/16	1/2	SS-DAM-DFT9-NS8	3.64 (92.4)	0.31 (7.9)	0.87 (22.2)	1.06 (27.0)	
3/4	3/4	SS-DAM-DFT12-NS12	4.22 (107.1)	0.39 (10.0)	1.06 (27.0)	1.38 (34.9)	
1	1	SS-DAM-DFT16-NS16	4.84 (123.0)	0.66 (16.7)	1.38 (34.9)	1.88 (47.6)	

① The adapters will be preassembled with ferrules before shipping. Please follow the Reinstallation Instructions in H-06 when installing the adapters.

Installation Instructions

Please see H-05.

Connection Information

Please see I-02.

Ordering Number Description

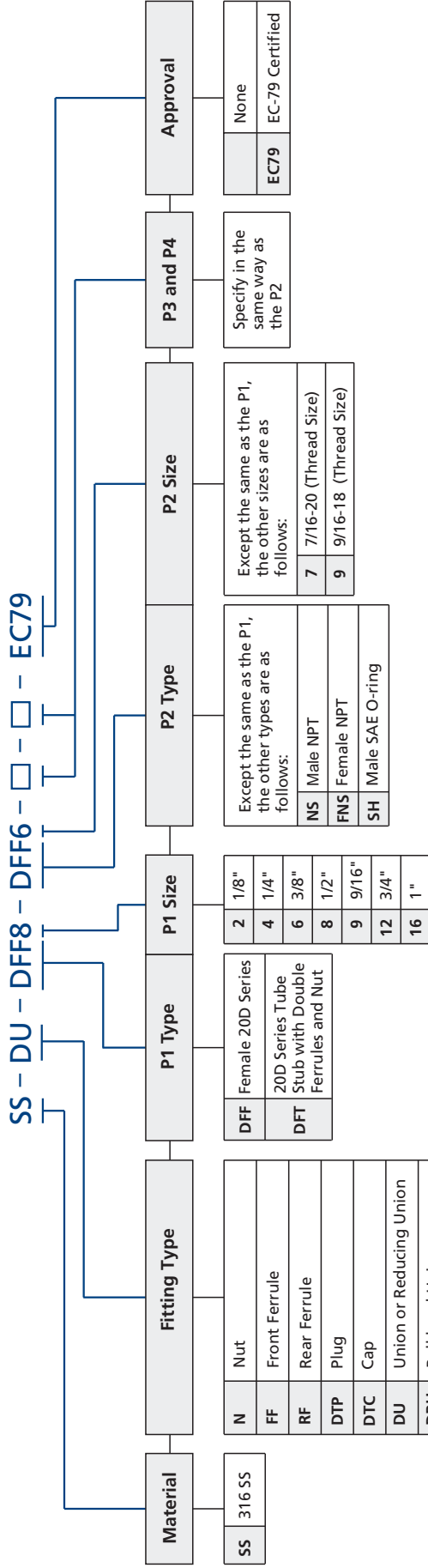

NOTES: 1. For more details regarding 20D Series connection, please see **Connection Information** on I-02.

2. "Ordering Number Description" is a reference to understand the combination rules of FITOK product part number. Not all combinations are available.